

PROJECTA

12 VOLT

BATTERY & ELECTRICAL SYSTEM ANALYSER



P/No. BLT700

KIT CONTENTS

1. Battery analyser
2. Storage case
3. Battery chart
4. USB Cable
5. Software on CD
6. Printer paper



OVERVIEW

1. LCD display
2. Red positive(+) connection
3. Black negative (-) connection
4. USB connection
5. USB button
6. EXIT / BACK button
7. Directions buttons
8. ENTER button
9. PRINT button
10. Status indicator (GREEN)
11. Power indicator (RED)
12. Thermal printer



INSTALLING PAPER

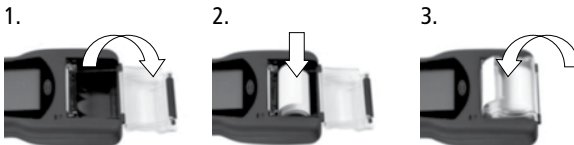

SETUP

1. Connect clips to battery. Bootup screen should briefly be displayed. If error is displayed check clamps
2. Brightness adjust
3. Setting Time & Date

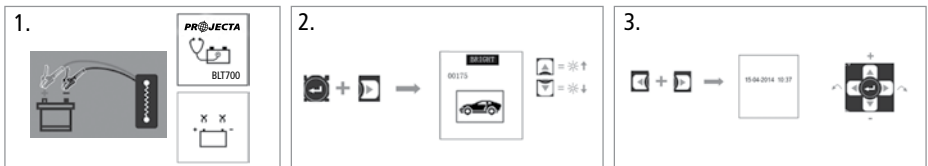

MAIN MENU

1. New test

Select this option to start a new set of tests. Enter a unique reference for the test e.g. vehicle licence plate number

2. Continue testing

Select this option to add more test results to those last viewed or stored in memory

3. View & print results

Select results to view then press 'Enter'. Results can then be printed by pressing PRINT button

1. Time & Date 2. Vehicle type 3. Vehicle ID e.g. licence plate 4. Test result

5. '***' indicates a bad reading

Note: results cannot be printed whilst tester is connected to a PC

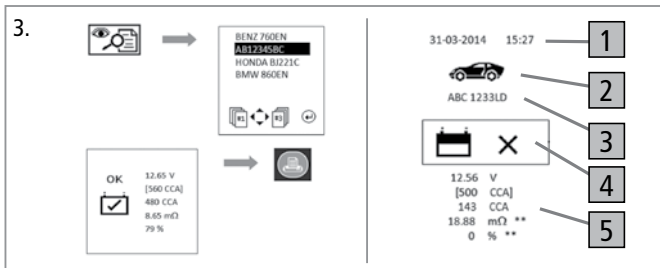
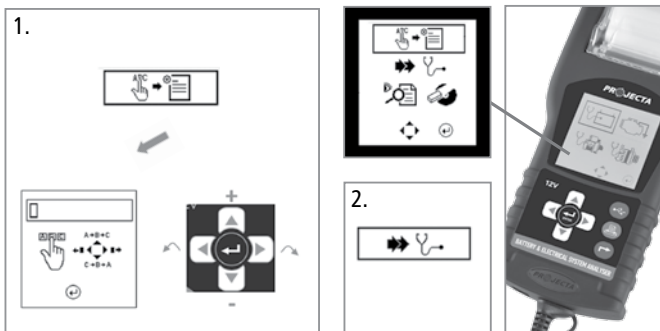

4. Delete results

SINGLE Result: Select result to delete then press 'Enter', press 'Enter' again to confirm delete
ALL Results: Pressing < and > keys for a few seconds will delete ALL results in memory

5. Select battery range

After selecting 'new test' or 'continue testing', select a suitable battery range

1. HIGH RANGE e.g. Car / Van 2. LOW RANGE e.g. Motorcycle

6. Select type of test

1. BATTERY TEST 2. EARTH TEST * 3. STARTER TEST * 4. ALTERNATOR TEST *

* - These tests are only available when using HIGH RANGE

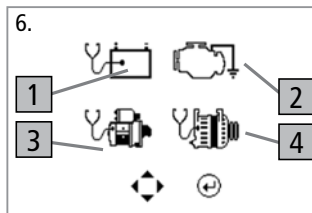
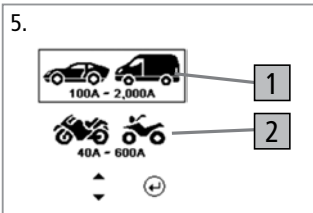
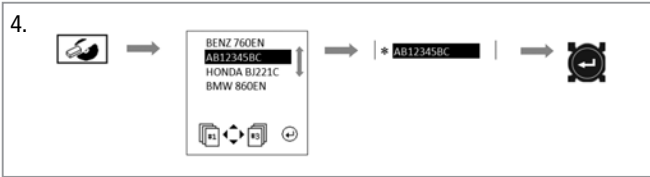

BATTERY TEST

Select this option to check cranking ability of the vehicle battery. If a vehicle has recently been used, the battery may have a surface charge, which could effect the results. If this is the case you will be prompted to turn on the headlights until the surface charge has been removed. If the battery voltage is low (below 12 volts) it may still be tested but a warning will be given prior to starting the test.

1. Select battery type

Select battery type to be tested

2. Select battery rating standard

If the battery standard is unknown then select '??'

3. Take note of cold cranking amps (CCA) rating from battery label

4. If CCA rating is unknown, use the table below

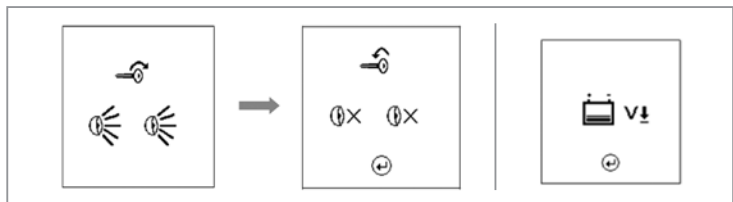

1.

	Standard Wet (EN/IEC)	Low Maintenance (EN/IEC)	Maintenance Free (CA/CCA)	STANDARD BATTERIES		
				AGM Free Plate	AGM Sprinkle Plate	EFB
WET	✓	✓				
EFB						✓
AGM			✓	✓	✓	
AGM Sprinkle Plate						

2.

3.

4.

CCA	CCA
1000 – 1299 cc	300 CCA
1300 – 1599 cc	400 CCA
1600 – 1999 cc	500 CCA
2000 – 2999 cc	700 CCA
3000 – 3500 cc	800 CCA

5. For JIS ratings, refer to supplied conversion chart to get CCA value
6. Enter battery CCA rating then press 'Enter'
7. Battery analysis will begin
8. During analysis you may be asked to confirm if battery has been re-charged:
 - Select option 1 if battery was not re-charged before testing
 - Select option 2 if battery was re-charged before testing
9. After analysis results are displayed:
 1. Diagnosis (refer icons)
 2. Battery Volts
 3. Rated CCA
 4. Actual CCA
 5. Conductance
 6. State of Health
10. Temperature compensation

When the battery result is marginal, you will be requested to confirm if the temperature is above or below 0°C

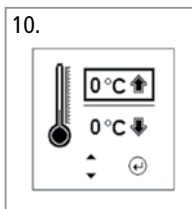
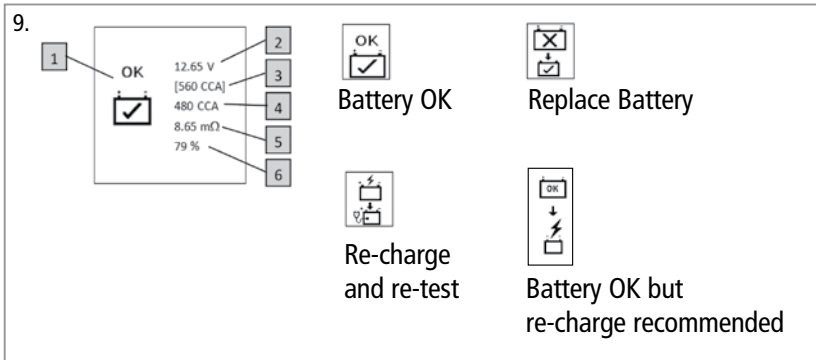
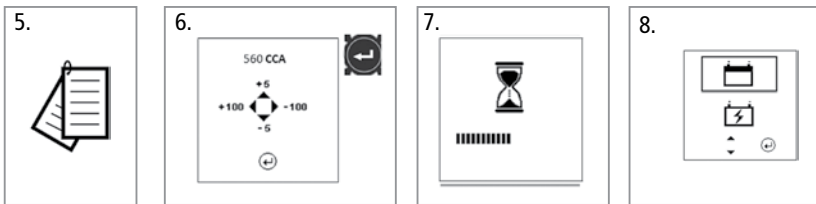

EARTH TEST

Select this option to check there is a good earth between battery and vehicle chassis

1. When prompted move the black[-] clip from battery[-] to vehicle chassis
2. Press 'Enter' to begin analysis
3. Now move black clip back to battery[-] within 15 seconds
4. Press 'Enter' to begin analysis
5. After analysis results are displayed:
 1. Ground connection normal
 2. High resistance, clean & tighten connections
 3. Ground not detected, repeat procedure

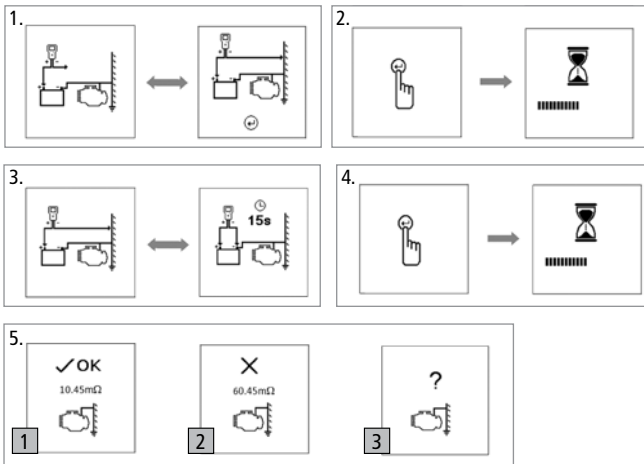

STARTER TEST

Select this option to check battery voltage is acceptable during starting

1. When prompted, start the engine within 30 seconds
2. After analysis results are displayed:
 1. Volt drop is normal
 2. Volt drop is too high, check starter system

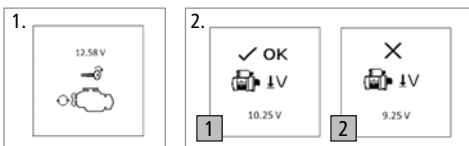

ALTERNATOR TEST

Select this option to check alternator charging voltages are acceptable

1. Rev engine to 3000RPM, press enter then hold revs for 10 seconds
2. After analysis results are displayed:
 1. Max allowable Charging Voltage
 2. Min allowable Charging Voltage
 3. Average measured Voltage
 4. Max measured Voltage
 5. Min measured Voltage

If any results are outside the allowable range, the result will flash and the alternator should be checked

3. With engine still running press Enter to continue
4. Switch on main electrical loads in vehicle then press 'Enter'
5. Rev engine to 2000RPM, press 'Enter' then hold revs for 10 seconds
6. After analysis results are displayed:
 1. Max allowable Charging Voltage
 2. Min allowable Charging Voltage
 3. Average measured Voltage
 4. Max measured Voltage
 5. Min measured Voltage

If any results are outside the allowable range, the result will flash and the alternator should be checked

7. Press 'Enter' to advance to Diode Ripple test
8. Ensure headlights only are switched on then press 'Enter' to start test
9. After analysis results are displayed:
 1. Diode ripple within limits
 2. Excessive diode ripple, check alternator

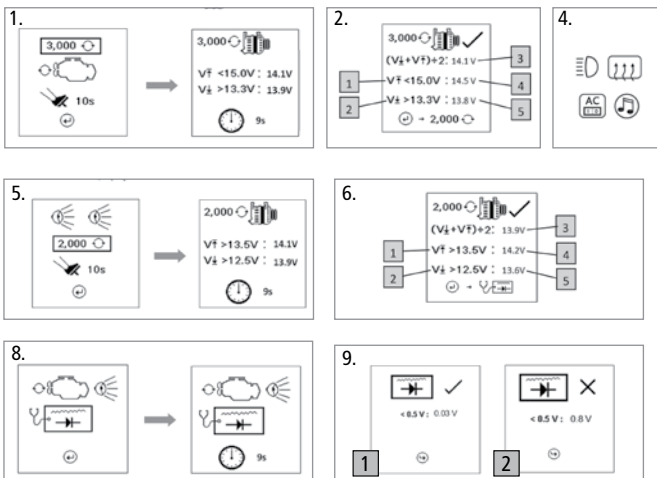

INDICATOR FUNCTIONS

1. Status indicator (green):
Solid: tester connected to computer
Flashing: out of paper or printer overheated
2. Power indicator (red):
Solid: power connected



SOFTWARE INSTALLATION

1. Make sure BLT700 is not connected to computer
2. Insert CD into computer and open driver folder
3. Launch driver installer file
4. Follow instructions to install USB to Serial driver
5. Run setup file to install BLT700 software
6. Connect BLT700 to computer Unit will be detected and installed

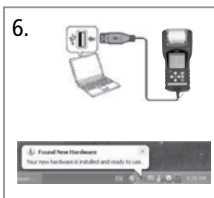
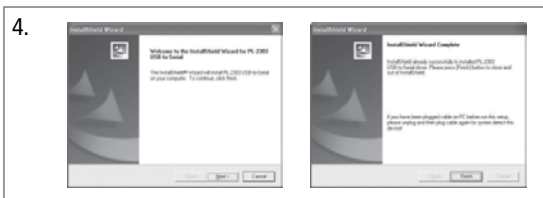

SOFTWARE OPERATION

1. Select result to download then press USB key
2. Display will indicate 'download mode' is active
3. Launch BLT700 software by clicking desktop icon
4. Main screen will display as shown
5. Before proceeding confirm a COM port has automatically been selected e.g. COM-4
6. Click icon to download data from analyser into computer
7. Enter any additional details required. Date, name, test reference e.g. licence plate battery model, battery rating in Amps
8. Click icon to add details to test report
9. Click icon to create Header/Footer information
10. Click icon to Print results
11. Click icon to Save results

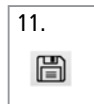
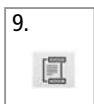
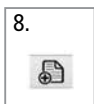
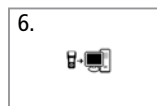
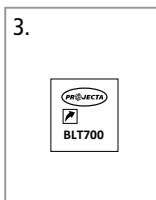
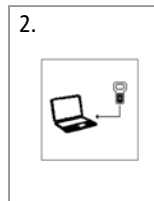
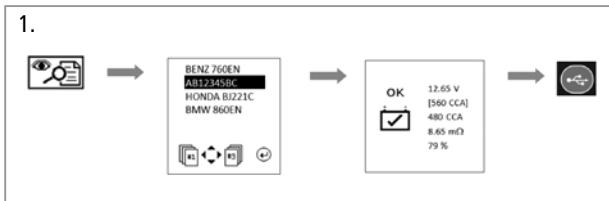

NOTES

WARRANTY STATEMENT

Applicable only to product sold in Australia

Brown & Watson International Pty Ltd of 1500 Ferntree Gully Road, Knoxfield, Vic., telephone (03) 9730 6000, fax (03) 9730 6050, warrants that all products described in its current catalogue (save and except for all bulbs and lenses whether made of glass or some other substance) will under normal use and service be free of failures in material and workmanship for a period of one (1) year (unless this period has been extended as indicated elsewhere) from the date of the original purchase by the consumer as marked on the invoice. This warranty does not cover ordinary wear and tear, abuse, alteration of products or damage caused by the consumer.

To make a warranty claim the consumer must deliver the product at their cost to the original place of purchase or to any other place which may be nominated by either BWI or the retailer from where the product was bought in order that a warranty assessment may be performed. The consumer must also deliver the original invoice evidencing the date and place of purchase together with an explanation in writing as to the nature of the claim.

In the event that the claim is determined to be for a minor failure of the product then BWI reserves the right to repair or replace it at its discretion. In the event that a major failure is determined the consumer will be entitled to a replacement or a refund as well as compensation for any other reasonably foreseeable loss or damage.

This warranty is in addition to any other rights or remedies that the consumer may have under State or Federal legislation.

IMPORTANT NOTE

Our goods come with guarantees that cannot be excluded under the Australian Consumer Law. You are entitled to a replacement or refund for a major failure and compensation for any other reasonably foreseeable loss or damage. You are also entitled to have the goods repaired or replaced if the goods fail to be of acceptable quality and the failure does not amount to a major failure.

Distributed by

AUSTRALIA

Brown & Watson International Pty Ltd

Knoxfield, Victoria 3180

Telephone (03) 9730 6000

Facsimile (03) 9730 6050

National Toll Free 1800 113 443

NEW ZEALAND

Narva New Zealand Ltd

22–24 Olive Road

PO Box 12556 Penrose

Auckland, New Zealand

Telephone (09) 525 4575

Facsimile (09) 579 1192