

**PROJECTA**

**6/12/24V 40A 8 STAGE AUTOMATIC**

# **WORKSHOP**

**CHARGER & BATTERY MANAGER**



P/No. HDBM4000

## **IMPORTANT SAFETY INFORMATION**

Please read this manual thoroughly before use and store in a safe place for future reference.

### **WARNINGS**

- Explosive gases. Prevent flames and sparks. Provide adequate ventilation during charging.
- Before charging, read the instructions.
- For indoor use. Do not expose to rain.
- For charging lead acid batteries ONLY (of the size & voltage specified in the specifications table).
- Always charge the battery on the correct voltage setting. Never set the charger to a higher voltage than the battery.
- Disconnect the 240V mains supply before making or breaking the connections to the battery.
- The battery charger must be plugged into an earthed socket-outlet.
- Connection to supply mains is to be in accordance with National wiring rules.
- Do not attempt to charge non-rechargeable batteries.
- Never charge a frozen battery.
- If the supply cord is damaged, it must be replaced by a special cord or assembly available from the manufacturer or its service agent.
- Corrosive substances may escape from the battery during charging and damage delicate surfaces. Store and charge in a suitable area.
- Ensure all vehicle accessories including lights, heaters, appliances etc. are turned off prior to charging.
- This charger is not intended for use by persons (including children) with reduced physical, sensory or mental capabilities, or lack of experience and knowledge, unless they have been given supervision or instruction concerning use of the appliance by a person responsible for their safety.
- Young children should be supervised to ensure that they do not play with the appliance.
- Only use the hanger bolts provided with the docking station to mount on the back of the charger.

# INDEX

|  |                |
|--|----------------|
| <b>1. Features</b>                           | <b>Page 4</b>  |
| 1.1 Specifications                           | Page 6         |
| 1.2 Product Overview                         | Page 7         |
| 1.3 Assembly/Set Up                          | Page 9         |
| 1.3.1 Cable Calibration                      | Page 9         |
| <b>2. Operation</b>                          | <b>Page 10</b> |
| 2.1 Setting Battery Voltage                  | Page 11        |
| 2.2 Pulse Tronic Charge                      | Page 12        |
| 2.2.1 Charge Function Modes                  | Page 12        |
| 2.2.1.1 Storing Pulse Tronic Charge          | Page 14        |
| 2.2.1.2 Storing Supply/Diagnostic Mode       | Page 14        |
| 2.3 Battery and Alternator Test              | Page 15        |
| 2.3.1 Battery Test                           | Page 15        |
| 2.3.2 Charge System Test (Alternator)        | Page 16        |
| 2.3.3 Battery Starting Charge Capacity (CCA) | Page 17        |
| 2.4 Battery Maintenance                      | Page 18        |
| 2.4.1 Desulfation                            | Page 19        |
| 2.4.2 Equalization                           | Page 19        |
| 2.5 Power Supply                             | Page 21        |
| 2.5.1 Diagnostic                             | Page 22        |
| 2.5.2 Supply                                 | Page 23        |
| 2.6 Engine Start                             | Page 25        |
| 2.6.1 Procedure                              | Page 25        |
| 2.7 Alarms                                   | Page 26        |
| <b>3. FAQ's</b>                              | <b>Page 27</b> |

## 1. FEATURES

### AUTOMATIC 8 STAGE CHARGING

Automatic 8 stage charging delivers a complete and thorough charge giving your batteries longer life & better performance. Once the battery is fully charged, the battery charger will continue to monitor the battery without the risk of overcharging.

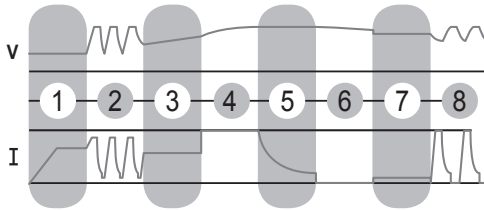

STAGE 1: Checks battery settings with battery

STAGE 2: Desulphation stage is designed to break down sulphation occurring in batteries that have been left flat for extended periods of time, returning them back to full charge. Sulphation occurs when lead-sulphate hardens and clogs up the battery cells.

STAGE 3: Soft Start, this is a preliminary charge process that gently introduces power to the battery, protecting the battery and increasing battery life.

STAGE 4: Bulk stage reduces charging time by charging the battery at the maximum rate (constant current) to a set voltage, at which point the battery is approximately 80% charged.

STAGE 5: Absorption stage charges the battery to 100% by adjusting the charge rate allowing the battery to absorb more power.

STAGE 6: Analysis mode tests the battery to ensure that it has taken the charge; if the battery passes the test the charger will proceed to Float stage, but if the battery fails the test, the charger will apply a recondition charge to try to return the battery to full charge.

STAGE 7: Float stage maintains the battery at 100% charge without overcharging or damaging the battery.

STAGE 8: Pulse Float, provides a long term storage charge to the battery by only providing charge when required.

### ENGINE START FUNCTION

Starts vehicles with a flat battery after a controlled 5 minute charge.

### LCD DISPLAY

The battery charger is fitted with an LCD digital display that displays the battery voltage & Amp readings, correct connection and other warning messages during operation.

### **AUTO/MANUAL ADJUSTABLE OUTPUT**

Manually or use the Automatic charge setting feature to adjust the rate of charge to best suit different battery sizes.

### **MULTI VOLTAGE OPERATION**

Suitable for charging 6V, 12V & 24V batteries.

### **SHORT CIRCUIT & POLARITY PROTECTION**

### **POWER SUPPLY MODE**

Supply Power to the vehicle whilst the battery is being charged.

### **DIAGNOSTICS POWER SUPPLY**

Supplies stabilised power to the vehicle's MCU whilst receiving software updates.

### **BATTERY CHEMISTRY SELECTION**

The Multi-Chem function allows you to set the charging profile to suit each battery's chemistry type (GEL, AGM, WET and Calcium). This ensures correct and thorough charging and maximises battery performance and battery life. The following section describes the charge profiles for each chemistry type.

### **MANUALY SET EQUALIZATION**

Manually configure an Equalization routine to balance all the cells of the battery.

### **MANUALY SET DESULPHATION**

Manually perform Desulphation on the battery.

### **BATTERY AND ALTERNATOR TESTING**

Test Battery Voltage. Performs a check on the Alternator. Checks the battery while starting.

### **SILENT MODE**

The charger can run with the fan turned off where it is important for the charger to be running silent, like a car show room.

### **OPTIONAL 6 & 10 METRE LEADS**

Optional 6 or 10 metre battery leads can be purchased for applications where longer leads are required.

## 1.1 SPECIFICATIONS

| P/No. HDBM4000                                     | 6V                     | 12V           | 24V   |
|--|------------------------|---------------|-------|
| Type   | 8 Stage Automatic      |               |       |
| Input  | 240V, 50Hz, 600W       |               |       |
| Output   | 3-40A                  | 3-40A         | 3-20A |
| Engine Start                                       | –                      | 70A for 3 sec | –     |
| Minimum Start Voltage                              | 2.0V                   | 2.0V          | 2.0V  |
| Charge Voltages (Absorption)                       |                        |               |       |
| AUTO   | 7.2V                   | 14.4V         | 28.8V |
| AUTO ✱   | 7.7V                   | 15.4V         | 30.8V |
| GEL  | 7.2V                   | 14.4V         | 28.8V |
| AGM  | 7.35V                  | 14.7V         | 29.4V |
| EFB<br>(Enhanced Flooded<br>Battery or Stop/Start) | 7.35V                  | 14.7V         | 29.4V |
| WET  | 7.7V                   | 15.4V         | 30.8V |
| AGM+ (Calcium)                                     | 7.5V                   | 15.0V         | 30.0V |
| Li (Lithium)                                       | 6.9V                   | 13.8V         | 27.6V |
| Float Voltage                                      | 6.8V                   | 13.6V         | 27.2V |
| Back Drain   | 20mA                   | 50mA          | 80mA  |
| Approvals  | Electrical Safety, EMC |               |       |

| Type             | 6 & 12V<br>Battery Range |      | 24V<br>Battery Range |      | Time |   |    |
|------------------|--------------------------|------|----------------------|------|------|---|----|
| Automotive (CCA) | 100                      | 3700 | 100                  | 2000 | 6    | – | 15 |
| Marine (MCA)     | 120                      | 4600 | 120                  | 2300 | 8    | – | 18 |
| Deep Cycle (AH)  | 14                       | 600  | 14                   | 300  | 7    | – | 17 |

## 1.2 PRODUCT OVERVIEW

FIGURE A

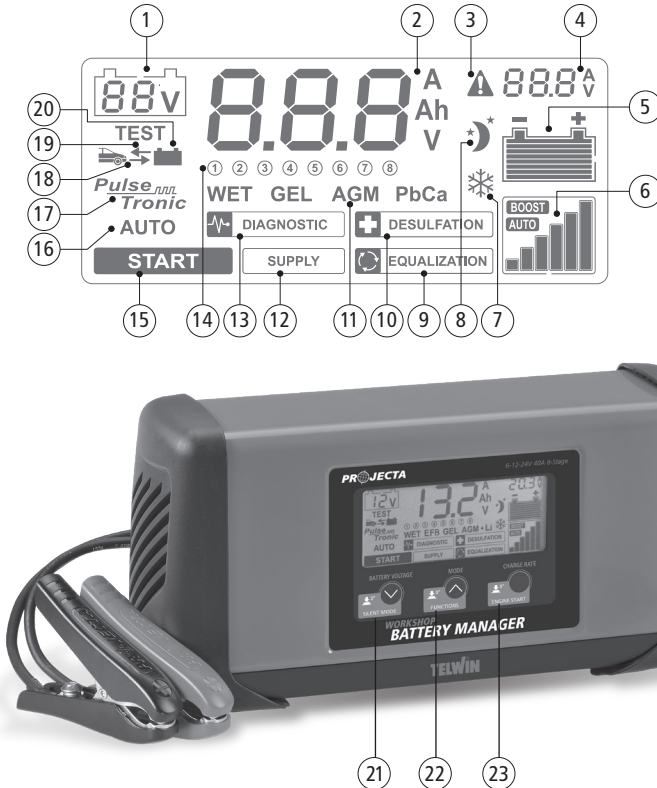

1. Display of the set battery voltage value.
2. Main display measured battery voltage, current, Ah selection, voltage value selected for the Supply / Diagnostic / Equalization programs, interface messages for the operator, alarm codes.
3. Polarity inversion, short circuit, worn out or faulty battery alarm.
4. Set current, voltage and Alarm codes "AL1 - AL9"
5. Battery charge level.
6. Choice of the Pulse Tronic charge current: AUTO, BOOST, Customised (Ah setting).
7. Low temperature function "COLD".
8. SILENT NIGHT function.
9. EQUALIZATION mode.
10. DESULFATION mode.

11. Choice of the battery production technology:
  - Wet: Regular flooded battery
  - EFB: Enhanced Flooded Battery or Stop Start battery
  - GEL: Gel battery
  - AGM: Absorbed glass mat battery
  - AGM+: Calcium batteries
  - Li: Lithium Float charge for Lithium Iron Phosphate batteries (LiFePO<sub>4</sub>).  
(This is not full charge, it is simply a float charge)
12. SUPPLY mode
13. DIAGNOSTIC mode
14. PULSE TRONIC charge process phases
15. START mode
16. Automatic charge mode
17. Pulse Tronic charge
18. Alternator Test Function
19. Battery starting capacity test
20. Battery charge status test
21. BATTERY VOLTAGE – Settings button:
  - Battery voltage 6/12/24V
  - Silent mode
  - Voltage/Current adjustment
22. MODE – Settings button:
  - Pulse Tronic CHARGE (AUTO, AUTO ✱, Wet, EFB, GEL, AGM, AGM+, Li)
  - TEST (battery status, vehicle alternator, battery starting capacity)
  - Advanced Programmes (DESULFATION, EQUALIZATION, DIAGNOSTIC, SUPPLY)
  - Voltage/Current adjustment
23. CHARGE RATE – Settings button:
  - Output current (AUTO, BOOST, customised)
  - START mode



### 1.3 ASSEMBLING CHARGING LEADS TO BATTERY CLAMPS

The HDBM400 battery charger is shipped with the battery clamps disconnected from the positive & negative charging leads.

#### **IMPORTANT:**

- The negative (Black) battery clamp must be connected to the charging lead with the black heat shrink on the lug.
- The positive (Red) battery clamp must be connected to the charging lead with the red heat shrink on the lug.

To connect both the positive and negative leads to the battery clamps refer to the instructions below:

1. Remove the M6 Dome head bolt from the clamp.
2. Fit the lug on the end of the charging lead to the battery clamp.
3. Tighten the lug.

**1.3.1 CABLE CALIBRATION:** the possibility of using different length charging cables requires initial calibration so as to compensate the drop in voltage along the cables.

#### **CALIBRATION PROCEDURE**

- press and hold the BATTERY VOLTAGE button (fig. A.21\*) and plug the cable into the mains socket;
- continue to hold the BATTERY VOLTAGE button (fig. A.21\*) until the digits “3 m” or “6 m” or “10 m” flash on the display;
- select the required value using the MODE button (fig. A.22\*);
- wait 5” for the selection to be confirmed.

\* Refer to the feature in figure A on page 7

## INITIAL CONDITION



## DEVICE OFF

Keep pressed the button "Battery Voltage" and plug into mains socket.  
Release button "Battery Voltage" after 7".

## BATTERY VOLTAGE

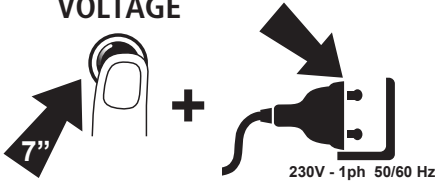

## CABLE CALIBRATION

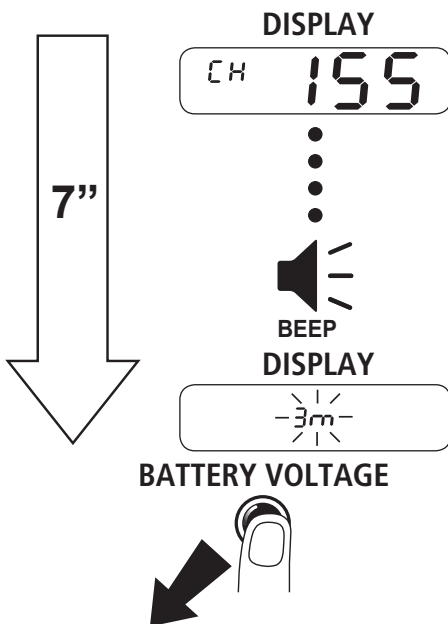

## 2. OPERATING INSTRUCTIONS

Follow the instructions in the order given below.

1. Remove the battery covers (if present), so that the gas produced during charging can exit.

- a. Make sure the level of electrolyte covers the battery plates; if they are not covered, add distilled water until they are submerged by 5–10 mm.  
**ATTENTION! BE VERY CAREFUL WHILE CARRYING OUT THIS OPERATION BECAUSE THE ELECTROLYTE IS AN EXTREMELY CORROSIVE ACID.**
2. Check the polarity of the battery terminals: the (+) symbol is positive, the (-) symbol is negative.
3. Connect the red clamp to the positive terminal on the vehicle battery (+ symbol).
4. Connect the black clamp to the vehicle chassis. Do not connect near the fuel pipe.
5. If the battery is not installed inside the vehicle, directly connect to the negative battery terminal (- symbol).

Charger can be used to Charge a battery, Test the battery Voltage, Test the cranking of the vehicle, Test the alternator, Perform equalization, Sulphation and Power Supply modes (Diagnostic and Powersupply mode).

When finished using the charger

6. Disconnect the battery charger by removing the power cable from the mains socket.
7. Disconnect the black charge clamps from the vehicle or from the negative battery terminal (- symbol). Disconnect the red charging clamp from the positive battery terminal (+ symbol).
8. Return the battery charger to a dry place. Close the battery cells again, using the relative caps (if present).

## 2.1 SETTING BATTERY VOLTAGE

Use the “BATTERY VOLTAGE” button (fig. A.21\*), to set the rated voltage for the battery (fig. A.1\*) to be charged.

### VOLTAGE SELECTION

#### BATTERY VOLTAGE

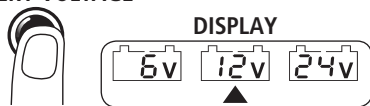

After connecting the clamps to the battery terminals:

- if the value detected is higher than the set value (fig. A.1\*), an “AL2” error message (fig. A.2\*) is displayed;
- if the value detected is lower than the set value, the display (fig. A.1\*) starts to flash for 5 seconds giving time to change the voltage value displayed in (fig. A.1\*).

NOTE: The “No Battery Connected” status is indicated by the flashing (fig. A.5\*) symbol.

\* Refer to the feature in figure A on page 7

## 2.2 PULSE TRONIC CHARGE

### 2.2.1 CHARGE FUNCTION MODES

There are various Pulse Tronic charge procedures that depend on the battery construction technology (T) and the charge current (C). When the battery is charged, the battery charger switches automatically to maintenance mode.

#### BATTERY TYPE SELECTION

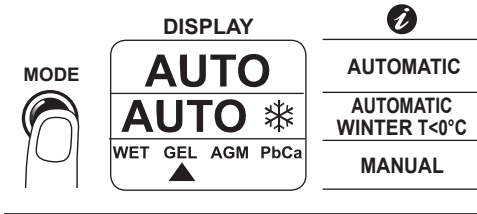

#### CURRENT SELECTION

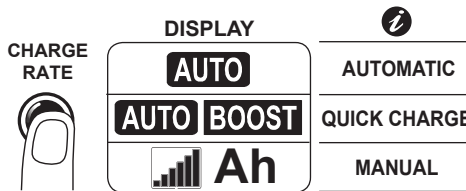

#### a) AUTOMATIC PULSE TRONIC

(T) AUTO (C) AUTO

Both the identification of the battery construction technology (fig. A.16\*) and the current needed to charge it function in automatic mode (fig. A.6\*). This function mode is recommended when there is no information on the battery type.

#### b) AUTOMATIC PULSE TRONIC AT LOW

TEMPERATURES (COLD fig. A.7\*)

(T) AUTO ❄️ (C) AUTO

Mode that improves the battery charge when the temperature is very low. Low temperature can influence the chemical structure of the battery components, therefore this function optimises the charge process according to this reduction in temperature.

This feature applies to the Wet, EFB, Cal, AGM batteries only.

When the battery is charged, the battery charger automatically switches to maintenance mode.

\* Refer to the feature in figure A on page 7

c) CUSTOMISED PULSE TRONIC

It is possible to select:

- the battery construction technology (fig. A.11\*) choosing between: "Wet, EFB, GEL, AGM, AGM+, Li"
- the charge current (fig. A.6\*) choosing between: "AUTO" - automatic setting according to battery conditions; "BOOST" - rapid charge;
- the Ah - customised setting of the battery Ah (fig. A.2\*) using 6 predefined values selected using the "CHARGE RATE" button (fig. A.23\*), adjustable at 5 Ah intervals using the "BATTERY VOLTAGE" button (fig. A.21\*), and "MODE" (fig. A.22\*).

**Ah SETTING – EXAMPLE**

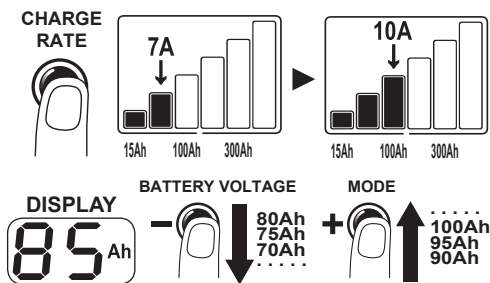

| Charge Rate Amps | Amp hours | CCA  |
|------------------|-----------|------|
| 3                | 15        | 90   |
| 7                | 70        | 420  |
| 10               | 100       | 600  |
| 20               | 200       | 1200 |
| 30               | 300       | 1800 |
| 40               | 600       | 3600 |

Note. The final charge voltage depends on the technology of construction of the battery; to avoid damaging the battery, pay special attention to the technical specifications given by the manufacturer.

The PULSE TRONIC charge process (fig. A.17\*) starts when the display stops flashing, each individual phase is identified on the display (fig. A.14\*) and terminates with the message (fig. A.2\*) "OK". The battery charge status is displayed graphically in (fig. A.5\*). If the charge process is not successful, an alarm message appears on the display (fig. A.2\*) (see alarms list page 26). When the battery is charged, the battery charger switches automatically to maintenance mode.

\* Refer to the feature in figure A on page 7

## END OF CHARGE – EXAMPLE



## CHARGE COMBINATION CHART

| Battery Type (T)                | Battery Current (C)               |
|---------------------------------|-----------------------------------|
| AUTO                            | Auto<br>Auto Boost<br>Manual 'Ah' |
| AUTO ✳                          | Auto<br>Auto Boost<br>Manual 'Ah' |
| Wet, EFB, GEL, AGM,<br>AGM+, Li | Auto<br>Auto Boost<br>Manual 'Ah' |

### 2.2.1.1 STORING PULSE TRONIC CHARGE

Storage of voltage and type of battery, charge mode.

#### Procedure:

- Check that the charge clamps are not connected to a battery;
- Connect the power cable to the mains socket;
- Set the desired charge mode;
- Disconnect the power cable from the mains socket.

### 2.2.1.2 STORING SUPPLY/DIAGNOSTIC MODE

Storage of delivered voltage and current.

#### Procedure:

- Set the chosen mode and adjust the voltage/current values as required;
- Turn on the lock settings by pressing, at the same time, both keys "BATTERY VOLTAGE" (fig. A.21\*) and "CHARGE RATE" (fig. A.23\*) for 3 seconds, on the display (fig. A.2\*) (fig. A.4\*) will appear "LOK on."

\* Refer to the feature in figure A on page 7

## 2.3 BATTERY AND ALTERNATOR TEST

The measurements can be performed with the battery connected to the vehicle, after connecting the clamps. Select the measurement to be performed using the "MODE" button (fig. A.22\*). On completing the test(s) disconnect the power cable from the mains socket and disconnect the clamps from the battery terminals.

NOTE: it is only possible to perform the tests without a power supply if the tests type selection is made after connecting the clamps to the battery terminals.

### 2.3.1 BATTERY TEST

Measure the voltage of the battery terminals.

#### BATTERY TEST SELECTION

MODE

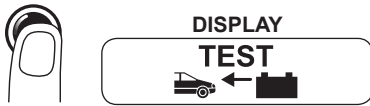

#### Procedure:

- press the "MODE" button (fig. A.22\*) to select the function and the battery type (fig. A.20\*);
- connect the clamps to the battery terminals;
- press the "BATTERY VOLTAGE" button (fig. A.21\*) to select the battery voltage (fig. A.1\*).

The measured voltage is indicated on the display (fig. A.2\*) and the battery status is indicated in graph format (fig. A.5\*).

#### END OF TEST - EXAMPLE

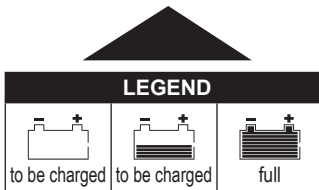
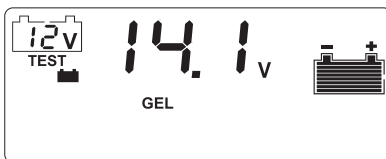

\* Refer to the feature in figure A on page 7

## 2.3.2 CHARGE SYSTEM TEST (ALTERNATOR)

Measure the voltage of the battery terminals.

### ALTERNATOR TEST SELECTION

MODE



DISPLAY



#### Procedure:

- press the “MODE” button (fig. A.22\*) to select this function (fig. A.18\*); the message “Bad” appears on the display (fig. A.2\*);
- connect the clamps to the battery terminals;
- press the “BATTERY VOLTAGE” button (fig. A.21\*) to select the battery voltage (fig. A.1\*);
- switch on the engine, taking it to approx. 1500 rpm;
- switch on all the lights (full headlights, courtesy lights, etc.) and all the accessories at maximum level (air conditioning, radio, etc.);
- check the display (fig. A.2\*) to read the alternator functions and following status:
  - “OK” – CHARGING IN PROGRESS;
  - “SUF” – SUFFICIENT CHARGE;
  - “BAD” – INSUFFICIENT CHARGE.

#### END OF TEST – EXAMPLE



| LEGEND  |            |              |
|---------|------------|--------------|
| OK      | SUF        | bad          |
| working | sufficient | insufficient |

\* Refer to the feature in figure A on page 7



### 2.3.3 BATTERY STARTING CHARGE CAPACITY (CCA)

Measure the voltage of the battery terminals.

#### CCA TEST SELECTION

MODE



#### Procedure:

- press the “MODE” button (fig. A.22\*) to select this function (fig. A.19\*);
- connect the battery terminal clamps, the message “Go” appears on the display (fig. A.2\*);
- press the “BATTERY VOLTAGE” button (fig. A.21\*) to select the battery voltage (fig. A.1\*);
- start the engine;
- check the display (fig. A.2\*) to read the battery starting capacity and the following status:
- “OK” - STARTING CAPACITY OK;
- “SUF” - SUFFICIENT STARTING CAPACITY;
- “BAD” - INSUFFICIENT STARTING CAPACITY.

#### END OF TEST – EXAMPLE

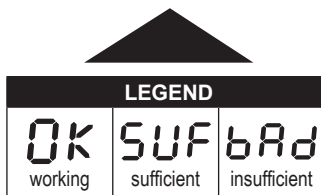

\* Refer to the feature in figure A on page 7

## 2.4 BATTERY MAINTENANCE

The device has two advanced operating modes for the maintenance of 6/12/24V batteries (ADVANCED PROGRAMS), press and hold the "MODE" button for 3 seconds (fig. A.22\*) recommended for AGM and WET type batteries:

- DESULFATION: recovery of sulphated batteries (fig. A.10\*);
- EQUALIZATION: reset of optimal battery conditions (fig. A.9\*).

### ADVANCED MENU SELECTION

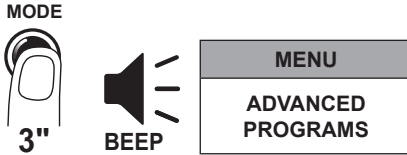

On completing the selected process, disconnect the power cable from the mains socket and disconnect the clamps from the battery terminals.

**BUTTON LOCK:** It is possible to lock and unlock the setting by simultaneously pressing and holding the "BATTERY VOLTAGE" (fig. A.21\*) and "CHARGE RATE" (fig. A.23\*) buttons for 3 seconds, and (fig. A.2\*) (fig. A.4\*) "LOK on" and "LOK off" will appear respectively on the display.

### KEYBOARD LOCK

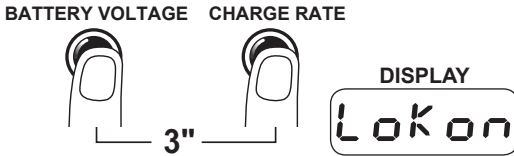

### KEYBOARD UNLOCK

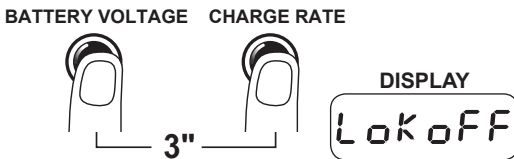

**TO EXIT THE "ADVANCED PROGRAMS" MENU:**

Press and hold the "MODE" button (fig. A.22\*) for 3 seconds.

### EXIT – ADVANCED MENU

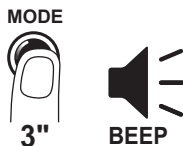

## 2.4.1 DESULFATION

Pulse system is used to recover sulphated batteries by applying enough voltage to neutralise the surface layers of oxide and revitalize the underlying plates. It is advisable to perform this operation with the battery disconnected from the vehicle.

### FUNCTION SELECTION

MODE



DISPLAY



**ATTENTION!** Pay particular attention to the nominal voltage of the battery which must correspond to the battery selected using the “BATTERY VOLTAGE” button and indicated on the display (fig. A.1). Not suitable for Lithium batteries.

#### Procedure:

- press the “MODE” button (fig. A.22\*) to select this function (fig. A.10\*);
- press the “BATTERY VOLTAGE” button (fig. A.21\*) to select the battery voltage (fig. A.1\*);
- connect the clamps to the battery terminals;
- the process starts automatically, with a variable duration depending on the battery response, displayed in graph format. If the desulfation process is completed successfully the word “End” will appear on the display (fig. A.2\*). In the case of highly sulphated batteries, hence irrecoverable, this process may not be completed; this condition is indicated when the charge phase continues to restart and the opening/closing of a relay is audible.

### END OF PROCESS – EXAMPLE

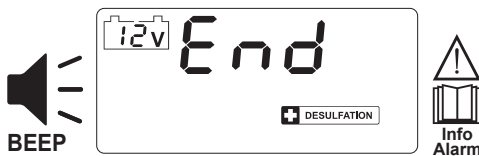

## 2.4.2 EQUALIZATION

This process is recommended for routine battery maintenance, to be performed periodically according to use.

### FUNCTION SELECTION

MODE



DISPLAY

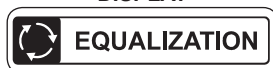

\* Refer to the feature in figure A on page 7

**ATTENTION!** Pay special attention to the type of battery being equalized (Wet, EFB, GEL, AGM, AGM+, Li): check the maximum allowed voltage to avoid damage.

### Customising the VOLTAGE

To customise the equalization voltage value simultaneously press and hold the "BATTERY VOLTAGE" (fig. A.21\*) and "MODE" (fig. A.22\*) buttons for 3 seconds, then use the same buttons to select (decrease using the "BATTERY VOLTAGE" button and increase using the "MODE" button), the desired voltage value between 6V-8.0V, 12V-16V, 24V-32V respectively for 6V, 12V, 24V batteries.

The factory default voltage value is respectively 6.8V, 13.6V, 27.2V.

The set voltage mode will be exited automatically after a 3" time-out.

### VOLTAGE ADJUSTMENT – EXAMPLE

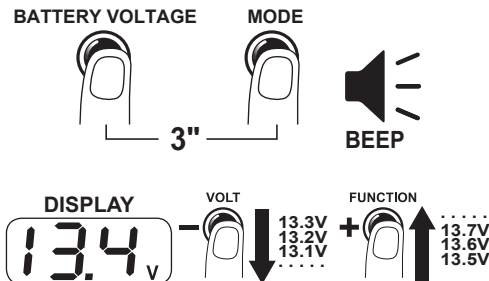

#### Procedure:

- press the "MODE" button (fig. A.22\*) to select this function (fig. A.9\*);
- press the "BATTERY VOLTAGE" button (fig. A.21\*) to select the battery voltage (fig. A.1\*);
- connect the clamps to the battery terminals;
- the equalization process will run automatically indicating the voltage value on the display (fig. A.2\*), along with the current (fig. A.4\*) output. On completing the process, the word "End" will appear on the display (fig. A.2\*).

### END OF PROCESS – EXAMPLE

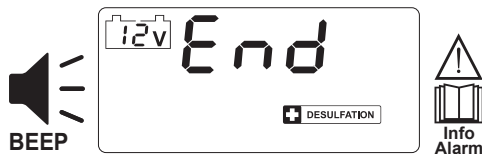

\* Refer to the feature in figure A on page 7

## 2.5 POWER SUPPLY

The device foresees 2 operating modes (ADVANCED PROGRAMS) as a generator stabilised at 6/12/24V:

- DIAGNOSTIC (fig. A.13\*);
- SUPPLY (fig. A.12\*).

### ADVANCED MENU SELECTION

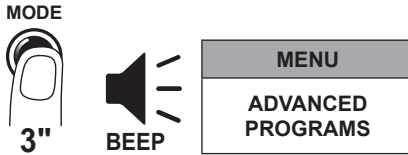

On completing the selected process, disconnect the power cable from the mains socket and disconnect the clamps from the battery terminals.

**BUTTON LOCK:** It is possible to lock and unlock the setting by simultaneously pressing and holding the "BATTERY VOLTAGE" (fig. A.21\*) and "CHARGE RATE" (fig. A.23\*) buttons for 3 seconds, and (fig. A.2\*) (fig. A.4\*) "LOK on" and "LOK off" will appear respectively on the display.

### KEYBOARD LOCK

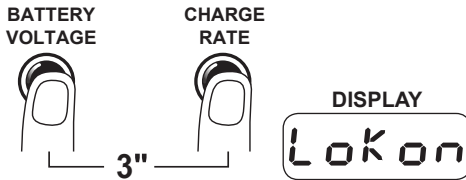

### KEYBOARD UNLOCK

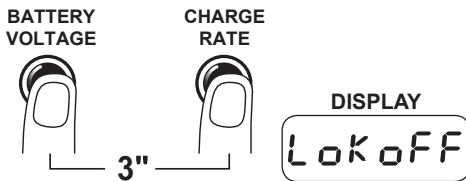

### TO EXIT THE "ADVANCED PROGRAMS" MENU:

Press and hold the "MODE" button for 3 seconds.

\* Refer to the feature in figure A on page 7

## 2.5.1 DIAGNOSTIC

Disturbance free precision power for supporting the battery during the vehicle electric system diagnostic operations (function used mainly in workshops).

### FUNCTION SELECTION

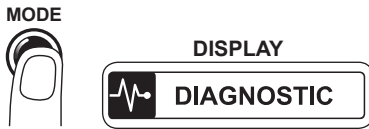

The set voltage is present on the charge clamps when connected to the battery.

NOTE: The battery must not be disconnected from the vehicle (so as not to lose the setup settings) and must have a minimal voltage of 5V to guarantee the correct functioning of the process.

**ATTENTION! Check the maximum permissible voltage on the vehicle manufacturer's technical specifications to prevent damage to the on-board electronics and the battery.**

### Customising VOLTAGE and CURRENT

#### VOLTAGE

- press and hold simultaneously the "BATTERY VOLTAGE" (fig. A.21\*) and "MODE" buttons (fig. A.22\*) for 3 seconds;
- use the same buttons to select (decrease using the "BATTERY VOLTAGE" button and increase using the "FUNCTION" button) the desired voltage value between 6V-7.5V, 12V-15V, 24V-30V respectively for 6V, 12V, 24V batteries; the factory default voltage value is respectively 6.8V, 13.6V, 27.2V.

The set voltage mode will be exited automatically after a 3" time-out.

### VOLTAGE ADJUSTMENT – EXAMPLE

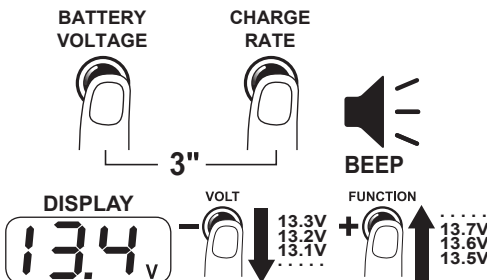

\* Refer to the feature in figure A on page 7

## CURRENT

- press the “CHARGE RATE” button (fig. A.23\*) until the desired value, set as indicated in step 6, appears on the display (fig. A.4\*) and on the icon (fig. A.6\*). The set current mode will be exited automatically after a 3” time-out.

## CURRENT ADJUSTMENT – EXAMPLE

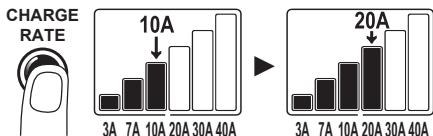

## PROCEDURE:

- press the “MODE” button (fig. A.22\*) to select this desired function (fig. A.13\* or fig. A.12\*); if necessary or requested by the vehicle manufacturer specifications, customise the voltage and/or current values as indicated below;
- use the “BATTERY VOLTAGE” button to select the battery voltage;
- connect the clamps to the relative vehicle battery terminals;
- the process will run automatically indicating the voltage value on the display (fig. A.2\*), along with the current (fig. A.4\*) after 5 seconds from the last operation.

## DISPLAY – EXAMPLE



## 2.5.2 SUPPLY

Constant voltage generator that can be used on Battery Changes or on batteries with a very low voltage (below 2V) to try to increase their voltage to a value that is suitable for starting with a normal charge cycle.

## FUNCTION SELECTION



**ATTENTION!** The set voltage is always present on the charge clamps even when disconnected from the battery.

**ATTENTION!** Pay particular attention to the nominal voltage of the battery which must correspond to the voltage selected using the “VOLT” button and indicated on the display (fig. A.1\*). This function DOES NOT HAVE spark protection on the output clamps and reverse polarity protection.

\* Refer to the feature in figure A on page 7

## Customising VOLTAGE and CURRENT

### VOLTAGE

- press and hold simultaneously the “BATTERY VOLTAGE” (fig. A.21\*) and “MODE” buttons (fig. A.22\*) for 3 seconds.
- use the same buttons to select (decrease using the “BATTERY VOLTAGE” button and increase using the “MODE” button) the desired voltage value between 6V-7.5V, 12V-15V, 24V-30V respectively for 6V, 12V, 24V batteries; the factory default voltage value is respectively 6.8V, 13.6V, 27.2V.

The set voltage mode will be exited automatically after a 3” time-out.

### VOLTAGE ADJUSTMENT – EXAMPLE

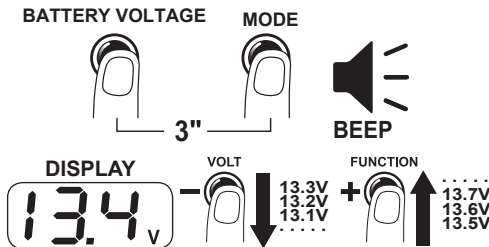

### CURRENT

- press the “CHARGE RATE” button until the desired value, set as indicated in step 6, appears on the display (fig. A.4\*) and on the icon (fig. A.6\*). The set current mode will be exited automatically after a 3” timeout.

### CURRENT ADJUSTMENT – EXAMPLE

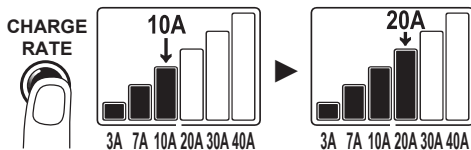

### CHANGE BATTERY PROCEDURE

- Press the “MODE” button (fig. A.22\*) to select the SUPPLY function (fig. A.12\*);
- if necessary or requested by the vehicle manufacturer specifications, customise the voltage and/or current values as indicated above;
- press the “BATTERY VOLTAGE” button (fig. A.21\*) to select the battery voltage (fig. A.1\*);
- connect the clamps to the relative vehicle battery terminals;
- change the battery paying particular attention not to disconnect the clamps from the vehicle terminals so as not to lose the electronic settings.

\* Refer to the feature in figure A on page 7



## 2.6 ENGINE START

START mode (fig. A.15\*), is available for 12V batteries and supplies 70 A current as a starter aid. If the battery is completely run down, it is advisable to perform a pre-charge cycle before proceeding.

### FUNCTION SELECTION

CHARGE  
RATE



DISPLAY



#### 2.6.1 Procedure

- press and hold the “CHARGE RATE” button (fig. A.23\*) for 3 seconds to select the “ENGINE START” function;
- connect the vehicle battery terminal clamps (the flashing message “Go” appears on the display (fig. A.1\*);
- now start the vehicle; a 30 second timer will engage and will appear on the display (fig. A.1\*), at the end of which it will be possible to start the engine again;
- on completing the selected process, disconnect the power cable from the mains socket and disconnect the clamps from the battery terminals.

### FUNCTION EXIT

CHARGE  
RATE



\* Refer to the feature in figure A on page 7

## 2.7 ALARMS

The alarms are displayed by a graph symbol (fig. A.3\*) when there is reverse polarity, short circuit, low or faulty battery.

The alarms will appear on the display (fig. A.2\*) and have the following meanings:

**AL1:** Reverse polarity and short circuit.

**AL2:** Battery voltage incompatible with selection.

**AL3:** PULSE TRONIC charge: has not completed the Desulphation within the 4 hour time limit, battery may not be recoverable.

**AL4:** PULSE TRONIC charge: has not completed Soft Start within the 4 hour time limit. The battery may not be recoverable.

**AL5:** PULSE TRONIC charge: has not completed bulk charge within the 18 hour time limit - The battery may not be recoverable.

**AL6:** PULSE TRONIC charge: The battery voltage dropped below 12.5V during analysis stage.

**AL7:** PULSE TRONIC charge: when the battery voltage is extremely low (<4.5V for 6V, <9.0V for 12V, <18.0 for 24V), the battery charger has 4 hours get above these voltages.

**AL8:** PULSE TRONIC charge: The battery has failed during Pulse Float. The battery may not be recoverable.

**AL9:** Short circuit in Supply/Diagnostic/Equalization functions.

\* Refer to the feature in figure A on page 7

### 3 FREQUENTLY ASKED QUESTIONS

#### Q. Why does the LCD screen indicate a fully charged battery straight away?

- A. There are two possible reasons why the LCD display may indicate a fully charged battery ('OK') straight away.
1. The battery is fully charged.
  2. The battery has taken a surface charge.

#### Q. What is Surface Charge?

- A. Batteries unused or left flat for some time build up a resistance to being recharged. When the charger is first connected, these batteries will take a surface charge, and the LCD display will indicate a fully charged battery within a short while. The battery however is not fully charged, the charger is voltage sensitive and cannot differentiate between a surface charge and a fully charged battery. After a few hours the battery may start to accept some charge but most batteries with this condition will not recover.

#### Q. What is a Faulty Cell?

- A. 12 Volt batteries contain 6 cells and one faulty cell is enough to ruin your battery. If after eight hours of charging your battery is still flat, you should test the cells using a hydrometer. If one reading is lower than the rest it indicates a faulty cell. It is pointless to continue charging, as the battery needs replacing.

#### Q. What are Volts and Amps?

##### **VOLTS**

The term voltage refers to the electrical force or electric potential to do work between two terminals or a good analogy is water pressure in a pipe. For example a battery has 12 Volts between the positive and negative terminals.

##### **AMPS**

The term AMPS is the unit of measure used for current. This can be described as the flow of electric charge in a circuit. Again if you use the water analogy this would refer to how much water is flowing through the pipe. For example if the current is reading 12 Amps then this is the amount of energy going into the battery.

# **WARRANTY STATEMENT**

## **Applicable only to product sold in Australia**

Brown & Watson International Pty Ltd of 1500 Ferntree Gully Road, Knoxfield, Vic., telephone (03) 9730 6000, fax (03) 9730 6050, warrants that all products described in its current catalogue (save and except for all bulbs and lenses whether made of glass or some other substance) will under normal use and service be free of failures in material and workmanship for a period of one (1) year (unless this period has been extended as indicated elsewhere) from the date of the original purchase by the consumer as marked on the invoice. This warranty does not cover ordinary wear and tear, abuse, alteration of products or damage caused by the consumer.

To make a warranty claim the consumer must deliver the product at their cost to the original place of purchase or to any other place which may be nominated by either BWI or the retailer from where the product was bought in order that a warranty assessment may be performed. The consumer must also deliver the original invoice evidencing the date and place of purchase together with an explanation in writing as to the nature of the claim.

In the event that the claim is determined to be for a minor failure of the product then BWI reserves the right to repair or replace it at its discretion. In the event that a major failure is determined the consumer will be entitled to a replacement or a refund as well as compensation for any other reasonably foreseeable loss or damage.

This warranty is in addition to any other rights or remedies that the consumer may have under State or Federal legislation.

## **IMPORTANT NOTE**

Our goods come with guarantees that cannot be excluded under the Australian Consumer Law. You are entitled to a replacement or refund for a major failure and compensation for any other reasonably foreseeable loss or damage. You are also entitled to have the goods repaired or replaced if the goods fail to be of acceptable quality and the failure does not amount to a major failure.

## **Distributed by**

### **AUSTRALIA**

**Brown & Watson International Pty Ltd**

Knoxfield, Victoria 3180

Telephone (03) 9730 6000

Facsimile (03) 9730 6050

National Toll Free 1800 113 443

### **NEW ZEALAND**

**Griffiths Equipment Ltd.**

19 Bell Avenue,

Mount Wellington,

Auckland 1060, New Zealand

Telephone (09) 525 4575

Facsimile (09) 579 1192