

# LPG SERIES-GEL Battery

## LPG12-50 (12V50AH)

### Specification

Nominal Voltage	12V	
Nominal Capacity(20HR)	50.0AH	
Dimension	Length	229±3mm (9.02 inches)
	Width	138±2mm (5.43 inches)
	Container Height	205±3mm (8.07 inches)
	Total Height (with Terminal)	211±3mm (8.31 inches)
Approx Weight	Approx 16.6 kg (36.60lbs)	
Terminal	T6	
Container Material	ABS	
Rated Capacity	50.0 AH/2.50A	(20hr, 1.80V/cell, 25°C/77°F)
	46.5 AH/4.65A	(10hr, 1.75V/cell, 25°C/77°F)
	40.0 AH/8.00A	(5hr, 1.75V/cell, 25°C/77°F)
	34.8 AH/11.6A	(3hr, 1.75V/cell, 25°C/77°F)
	27.5 AH/27.5A	(1hr, 1.67V/cell, 25°C/77°F)
Max. Discharge Current	500A (5s)	
Internal Resistance	Approx 9.0mΩ	
Operating Temp. Range	Discharge	-20~55°C (-4~131°F)
	Charge	0~40°C (32~104°F)
	Storage	-20~50°C (-4~122°F)
Nominal Operating Temp. Range	25±3°C (77±5°F)	
Cycle Use	Initial Charging Current less than 12.5A. Voltage	
	14.4V~15.0V at 25°C(77°F)Temp. Coefficient -30mV/°C	
Standby Use	No limit on Initial Charging Current Voltage	
	13.5V~13.8V at 25°C(77°F)Temp. Coefficient -20mV/°C	
Capacity affected by Temperature	40°C (104°F)	103%
	25°C (77°F)	100%
	0°C (32°F)	86%
Self Discharge	Leoch LPG series batteries may be stored for up to 9 months at 25°C(77°F) and then a freshening charge is required. For higher temperatures the time interval will be shorter.	



### Applications

- ◆ Telecommunications
- ◆ Solar system
- ◆ Wind power system
- ◆ Wheelchair
- ◆ Floor cleaning machines
- ◆ Golf trolley
- ◆ Boats



### Constant Current Discharge (Amperes) at 25 °C (77°F)

F.V/Time	20min	30min	45min	1h	2h	3h	4h	5h	6h	7h	8h	9h	10h	20h
1.85V/cell	42.3	33.2	25.3	21.2	13.5	10.3	8.49	7.33	6.33	5.60	5.05	4.62	4.37	2.40
1.80V/cell	48.5	37.1	27.9	23.4	14.6	11.0	9.00	7.70	6.64	5.86	5.29	4.86	4.56	2.50
1.75V/cell	54.5	40.8	30.2	25.1	15.4	11.6	9.43	8.00	6.88	6.07	5.46	5.00	4.65	2.55
1.70V/cell	58.7	43.7	32.1	26.5	16.4	12.1	9.74	8.25	7.12	6.27	5.63	5.13	4.76	2.58
1.67V/cell	61.1	45.4	33.2	27.5	16.8	12.5	10.0	8.42	7.23	6.36	5.71	5.20	4.82	2.61
1.60V/cell	66.2	48.6	35.7	29.2	17.5	13.0	10.4	8.68	7.41	6.50	5.81	5.31	4.91	2.65

### Constant Power Discharge (Watts/cell) at 25 °C (77°F)

F.V/Time	20min	30min	45min	1h	2h	3h	4h	5h	6h	7h	8h	9h	10h	20h
1.85V/cell	81.0	64.0	49.1	41.3	26.3	20.1	16.7	14.5	12.5	11.1	10.0	9.20	8.70	4.79
1.80V/cell	91.5	70.8	53.8	45.3	28.3	21.4	17.6	15.1	13.1	11.6	10.5	9.65	9.07	4.98
1.75V/cell	101.7	77.2	57.7	48.3	29.9	22.6	18.4	15.7	13.5	12.0	10.8	9.93	9.24	5.08
1.70V/cell	108.4	81.9	60.8	50.8	31.6	23.5	19.0	16.1	14.0	12.4	11.1	10.2	9.45	5.14
1.67V/cell	111.5	84.2	62.6	52.4	32.2	24.1	19.4	16.4	14.2	12.5	11.3	10.3	9.55	5.18
1.60V/cell	119.5	89.3	66.7	55.3	33.3	25.0	20.0	16.9	14.5	12.7	11.4	10.5	9.72	5.25

## Dimensions

### T6 Terminal

Unit: mm [inches]

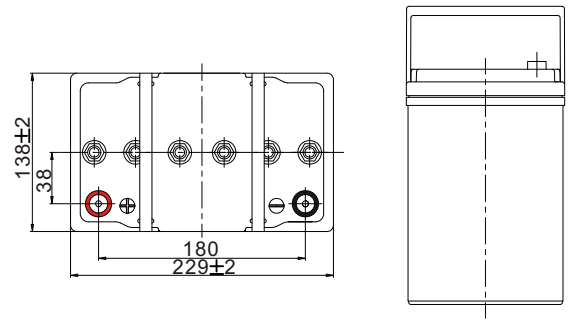
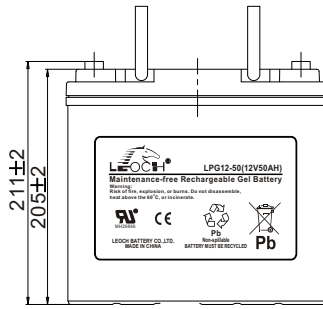
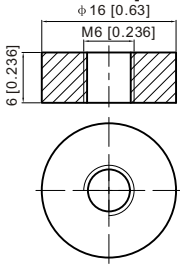

## Discharge Characteristics

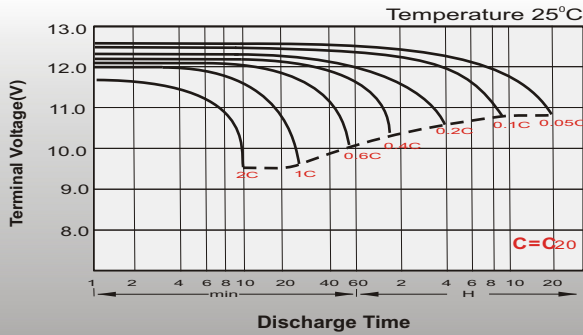

## Float Charging Characteristics

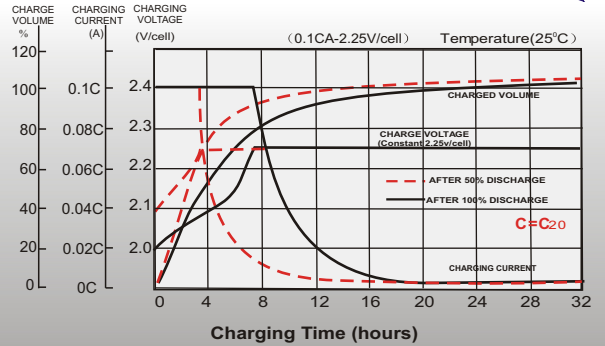

## Temperature Effects in Relation to Battery Capacity

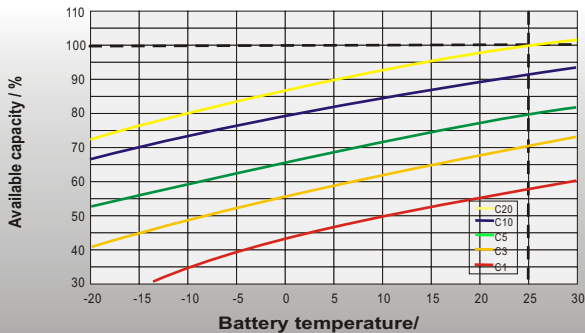

## Effect of Temperature on Long Term Float Life

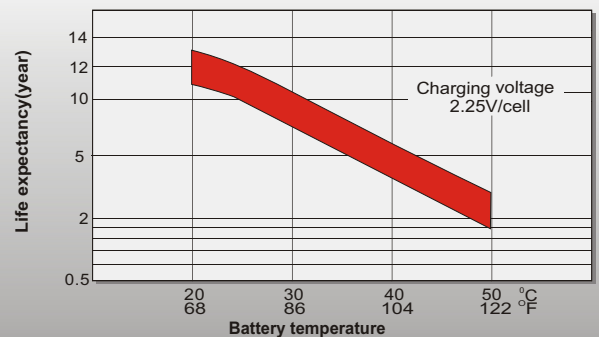

## Cycle Life in Relation to Depth of Discharge

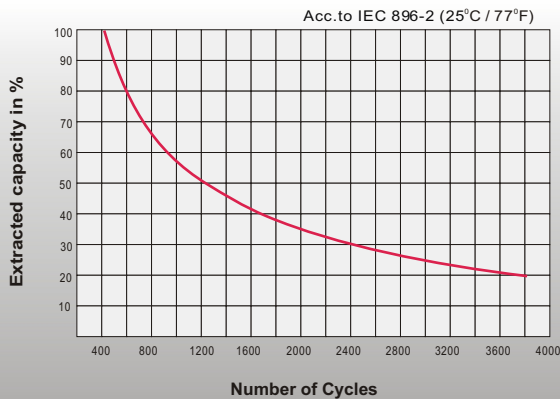

## General Relation of Capacity VS. Storage Time

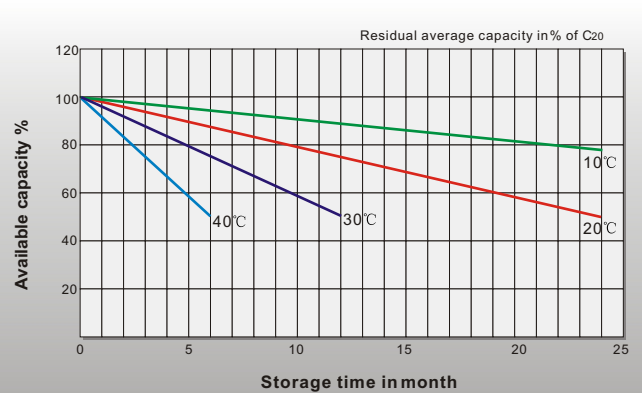

## Sales Office

### China sales office:

Add: 5th Floor, Xinbaohui Bldg., Nanhai Blvd.,  
Nanshan, Shenzhen, China. 518052  
Tel: +86-755-86036060 (100 lines)  
Fax: +86-755-26067269  
E-mail: export@leoch.com  
Http://www.leoch.com

### HongKong sales office:

Add: Workshop C, 33/F, TML Tower,  
No. 3 Hoi Shing Road, Tsuen Wan,  
New Territories, Hong Kong  
Tel: +852 35786666  
Fax: +852 21170016  
E-mail: sales.hk@leoch.com

### Singapore sales office:

Add: No. 1 Tech Park Crescent,  
Singapore 638131  
Tel: +65 68416629  
Fax: +65 68443210  
Email: sales.sg@leoch.com

### North America sales office:

Add: 19751 Descartes, Unit A,  
Foothill Ranch, CA 92610, USA  
Tel: 949-588-5853  
Fax: 949-588-5966  
E-mail: sales@leoch.us  
Http://www.leoch.com

### Europe sales office:

Add: 9B Wheatstone Court, Waterwells  
Business Park, Gloucester, GL2-2AQ,  
UK United Kingdom  
Tel: +44(0) 1452 729428 / 1452 729696  
Fax: +44 (0)1452-690125  
E-mail: Sales.Europe@leoch.com